

Sonniboy Ford Fiesta 5-door, Tür hinten rear door / kleines Seitenfenster small rear window /
Heckscheibe rear window 2008 →
0078201ABC

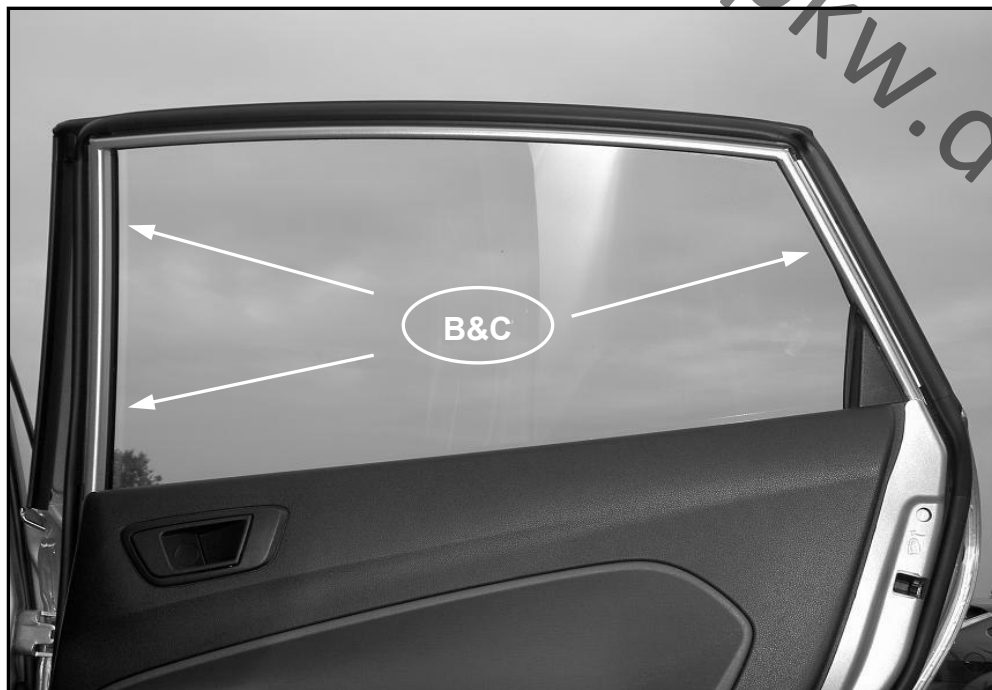

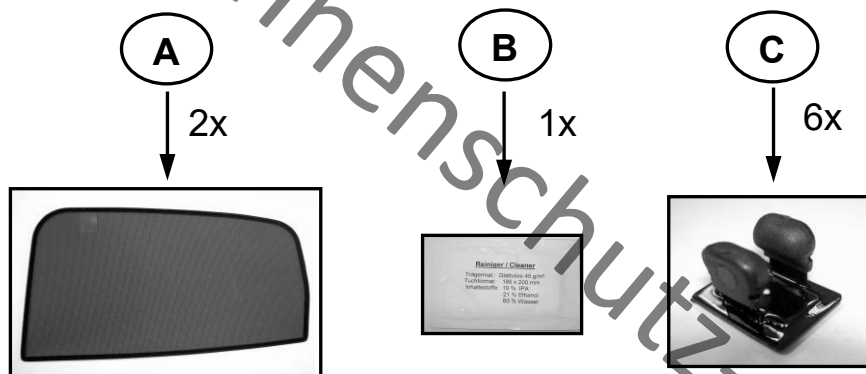

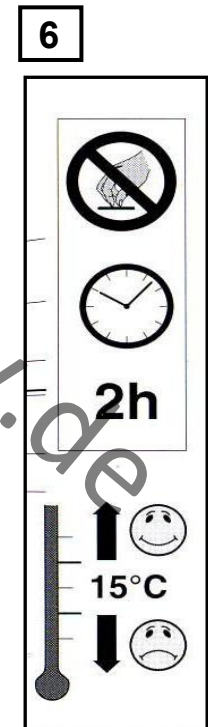
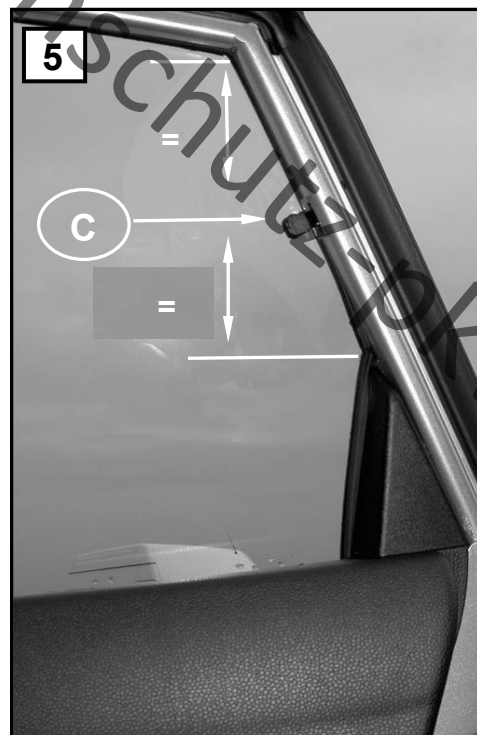
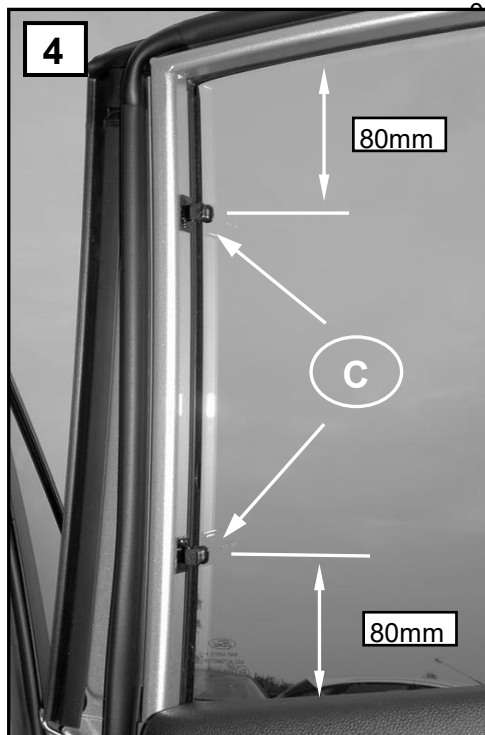
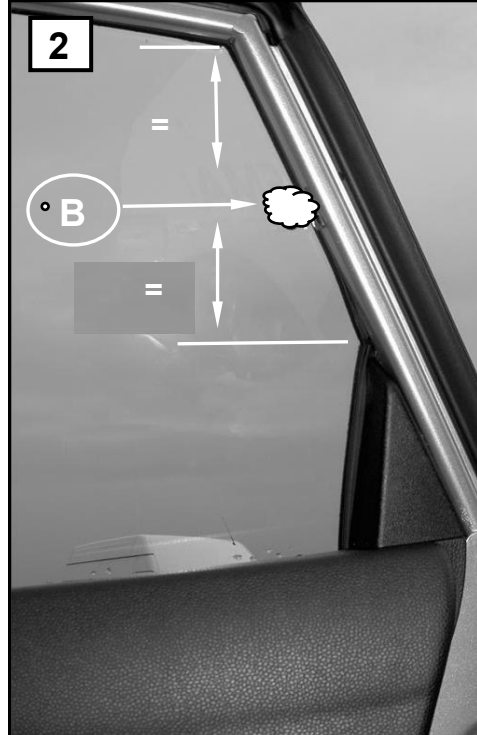
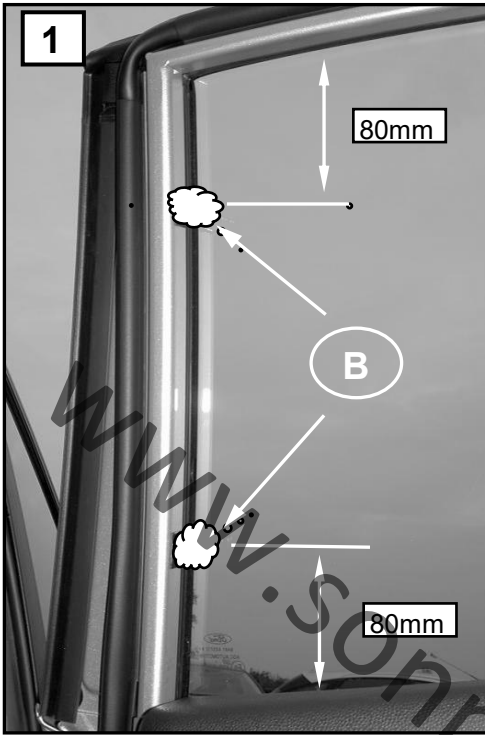
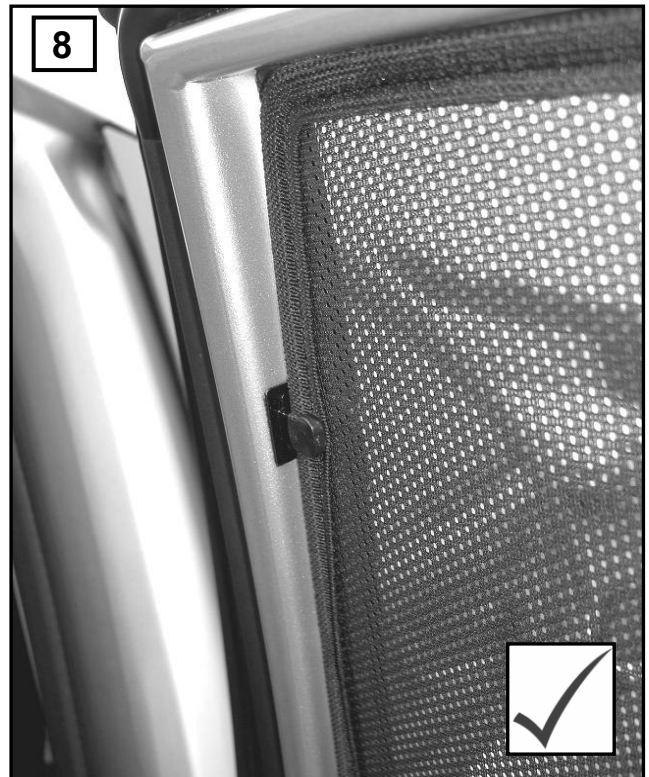
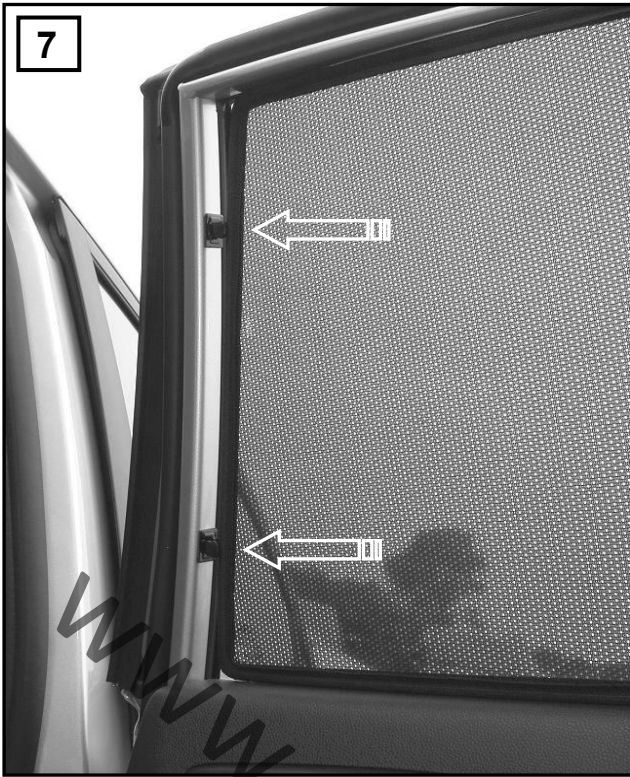

D
↓ 2x



E
↓ 2x

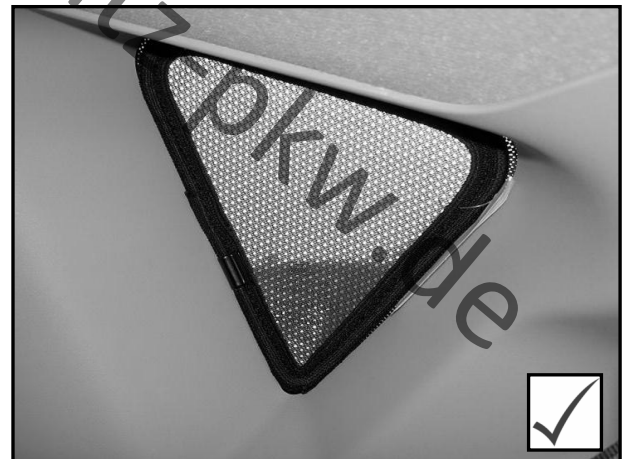
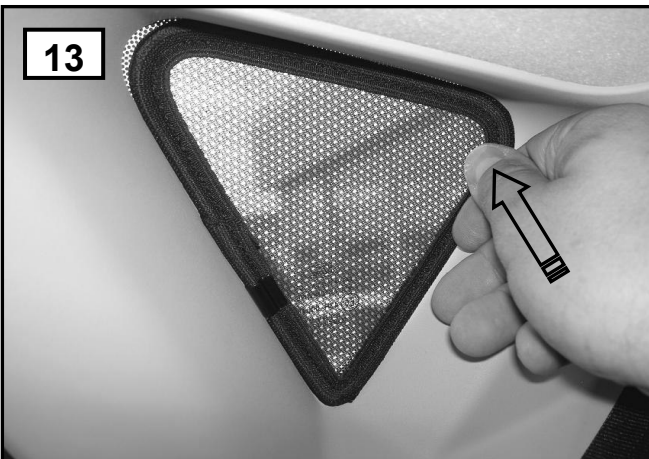

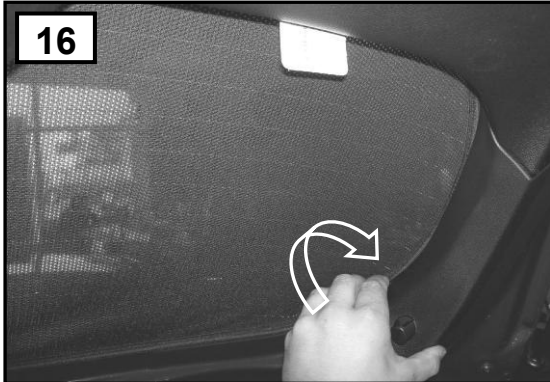
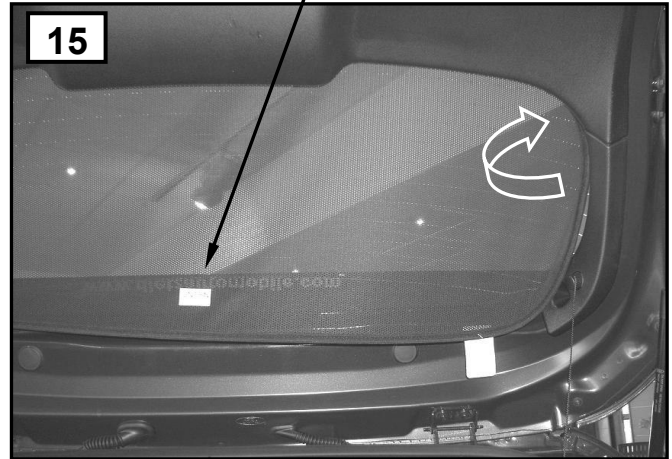
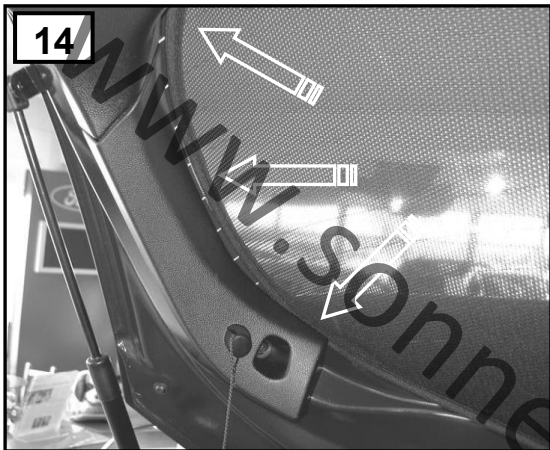
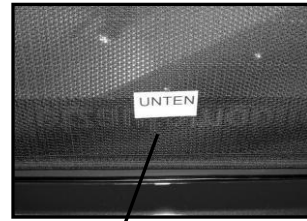
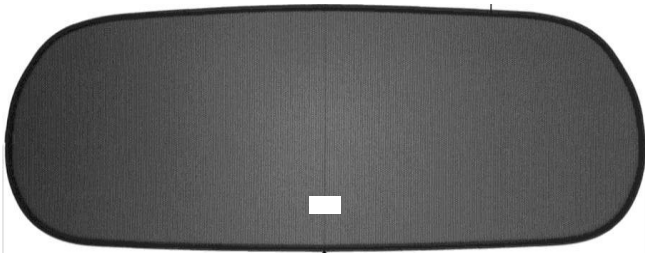
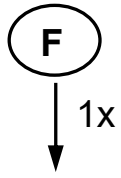

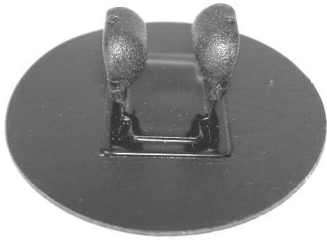

Hinweise zur Vermeidung von Fehlern beim Kleben

Recommendations for the prevention of errors during gluing

- Die zu verklebenden Oberflächen müssen sauber, trocken, fett- und staubfrei sein
The surfaces must be clean, dry, grease- and dust free
- Silikonhaltiges Cockpitspray ist unbedingt zu vermeiden
Cockpit spray which contains silicone has absolutely to be avoided
- Nach dem Reinigen mit dem Reinigungstuch darf erst nach vollständigen Abtrocknen verklebt werden
To be used only after complete drying and cleaning with cleaning cloth
- Die Oberflächentemperatur der Klebefläche soll während des Aushärtezeitraums (24 bis 48 Stunden) nicht unterhalb von 16°C und oberhalb von 35°C liegen. Direkte Sonneneinstrahlung ist im Aushärtezeitraum zu vermeiden
The surface temperature of the adhesive surface during curing time (24 to 48 hours) should not be below 16°C and not over 35°C. Direct sunlight should be avoided during curing time

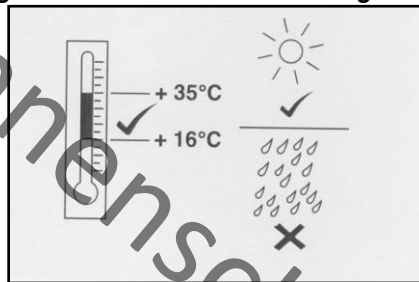

- Der Klebhalter sollte beim Ankleben mindestens 30 Sekunden fest angedrückt werden
The adhesive holders should be pressed firmly for 30 seconds during gluing.
- Die vollständige Klebekraft wird erst nach 48 Stunden erreicht
Full adhesion is reached after 48 hours only
- Der Sonnenschutz darf erst nach Erreichen der vollständigen Klebekraft eingebaut werden und muss spannungsfrei zwischen den Clips fixiert sein
The Sonniboy has to be installed only after reaching the full bond strength and has to be fixed without tension between the clips

